

<i>8.8.</i>		<i>8.8.</i>	
<i>8.8.</i>		<i>8.8.</i>	
<i>8.8.</i>		<i>8.8.</i>	

项目		规格
通信协议		IEC 61158 Type 12, IEC 61800-7 CiA 402 Drive Profile
应用层	SDO	SDO 请求、SDO 应答
	PDO	可变 PDO 映射
	CiA402	轮廓位置模式 (pp) 轮廓速度模式 (pv) 轮廓转矩模式 (pt) 原点复归模式 (hm) 同步周期位置模式 (csp) 同步周期速度模式 (csv) 同步周期转矩模式 (cst)
传输协议		100BASE-TX (IEEE802.3)
物理层	最大距离	100M
	接口	RJ45 * 2 (INT, OUT)

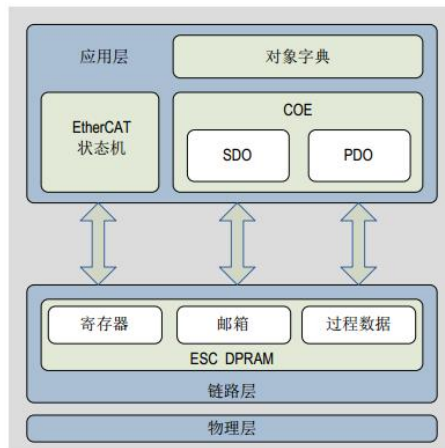

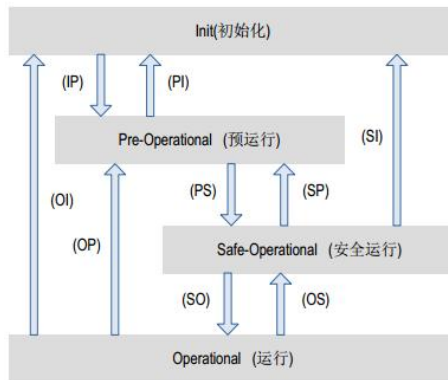

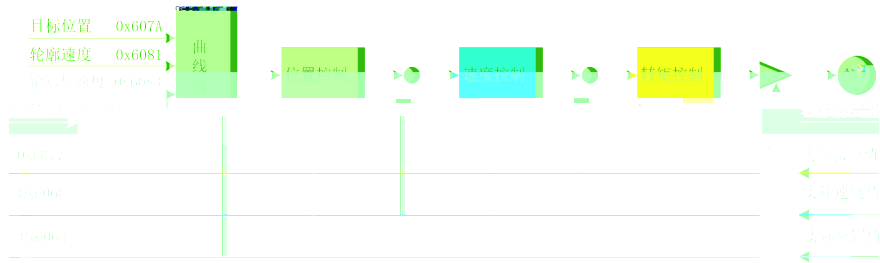







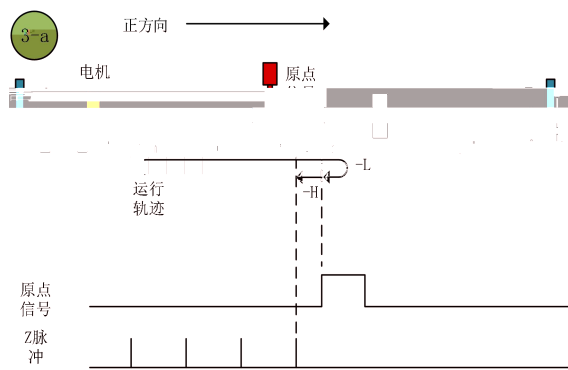
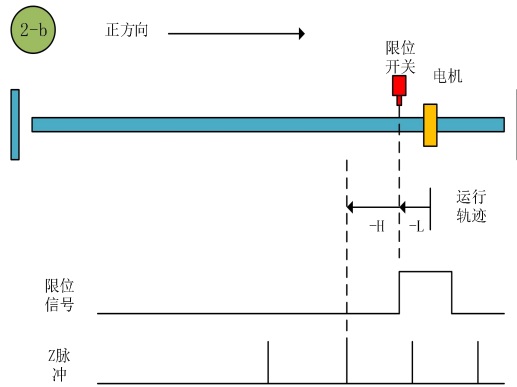
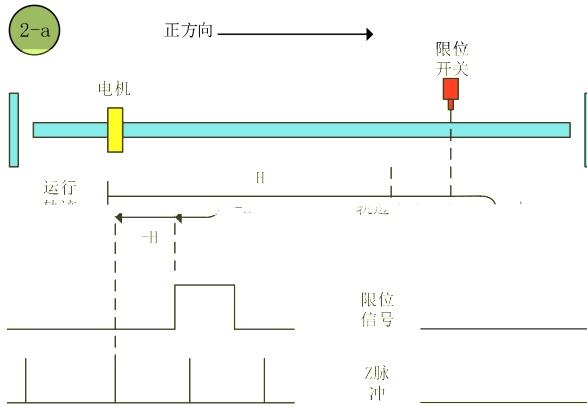

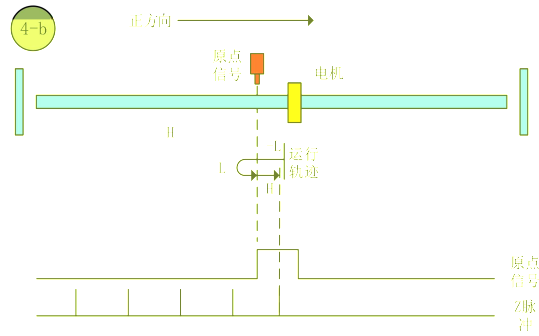
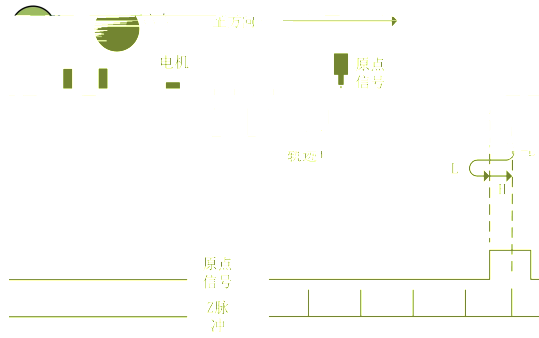
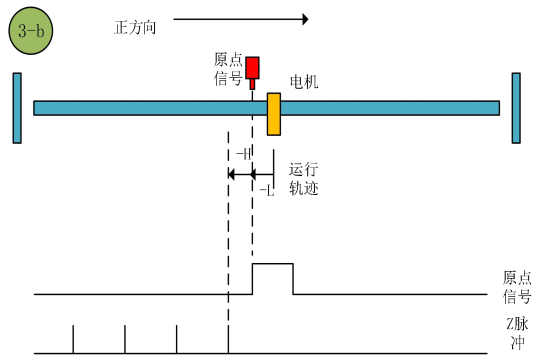

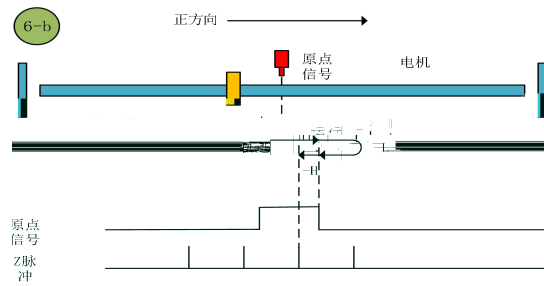
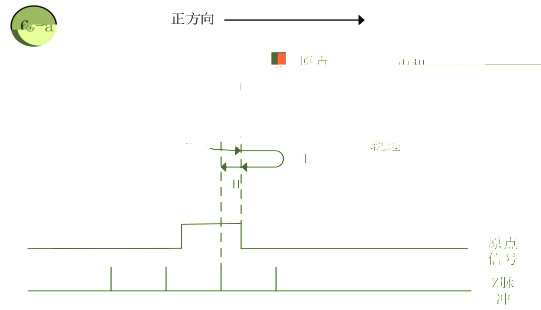
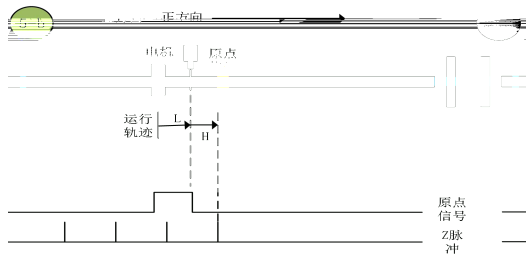
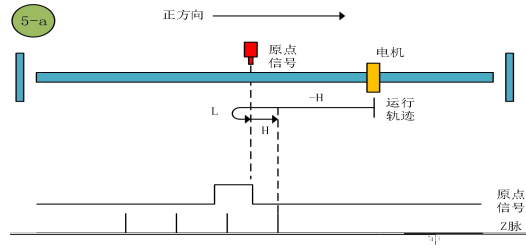

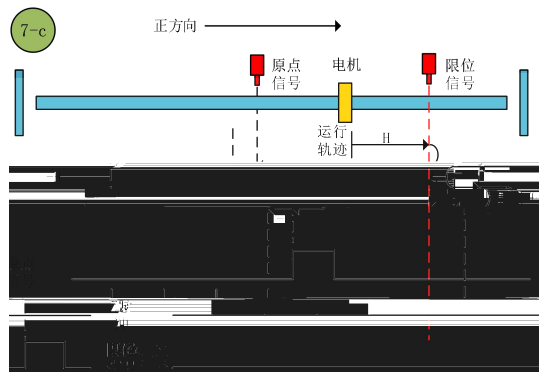
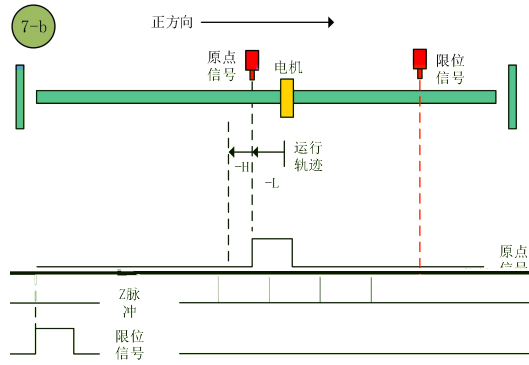
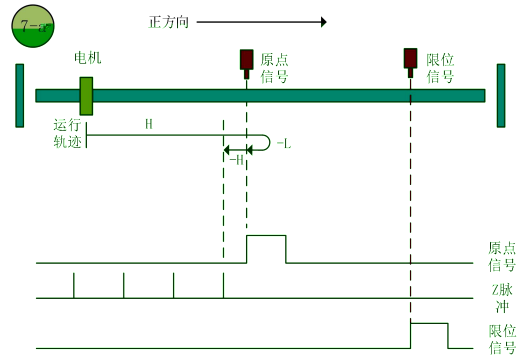

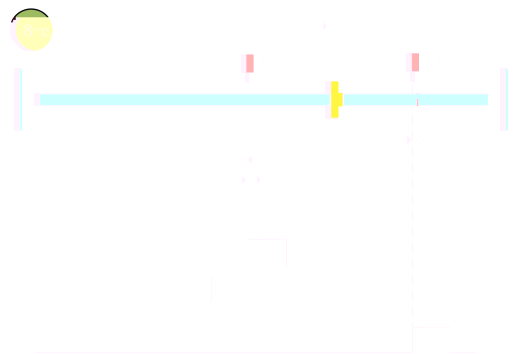
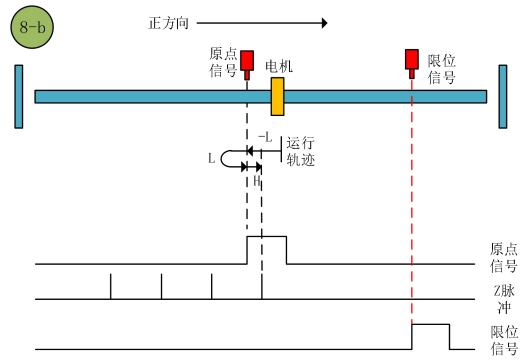
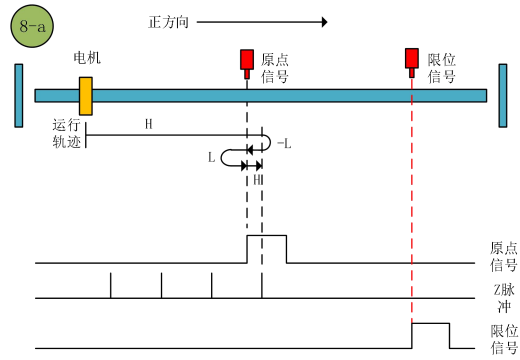







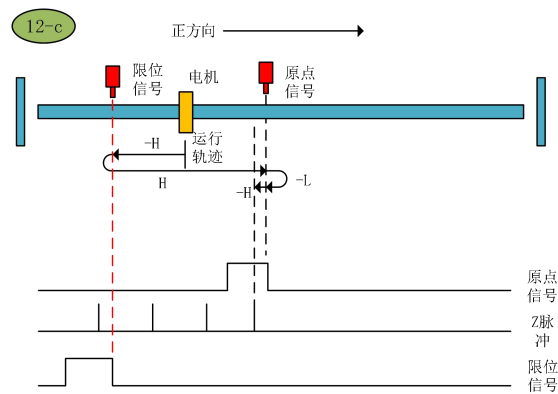
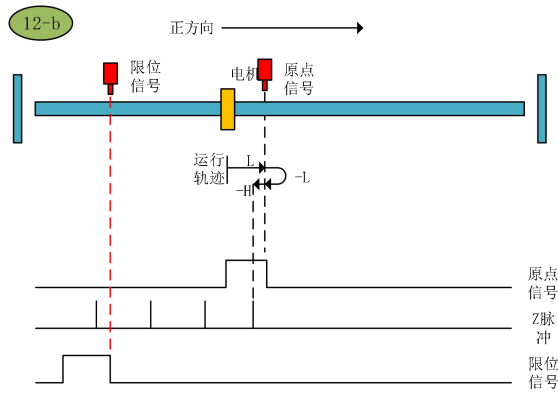
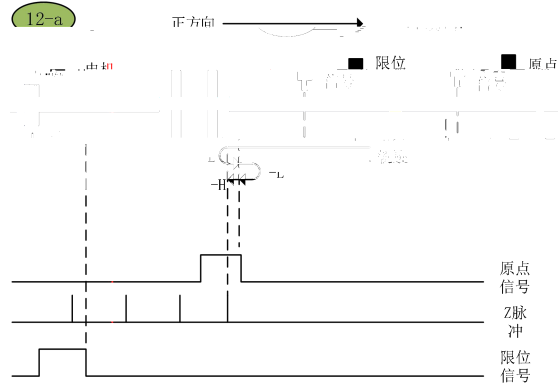



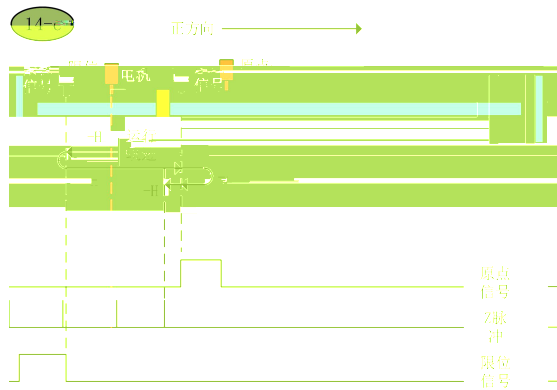
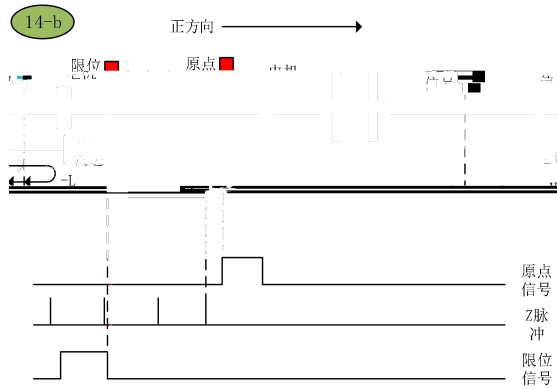
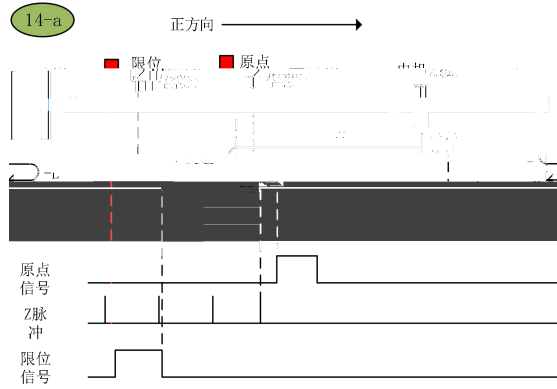

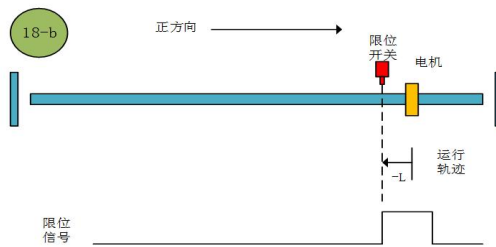
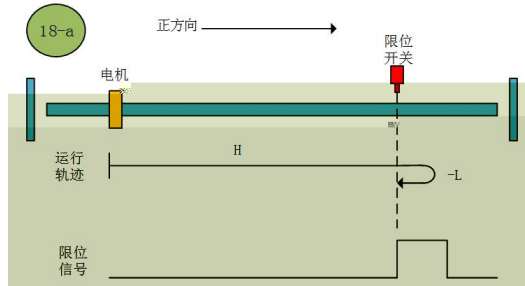
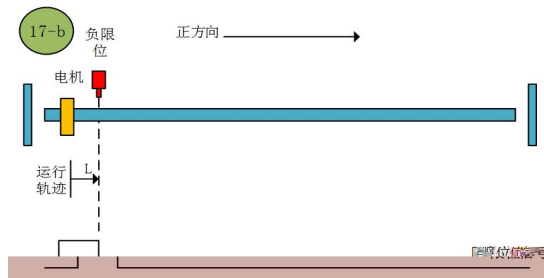



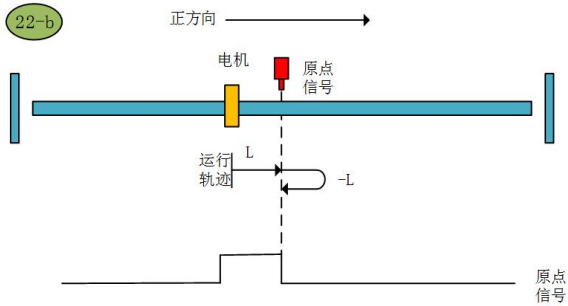
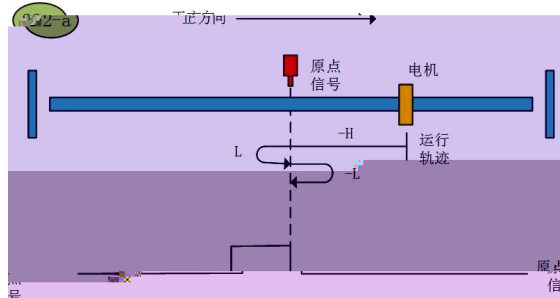
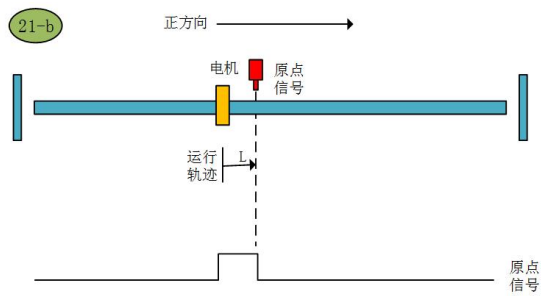
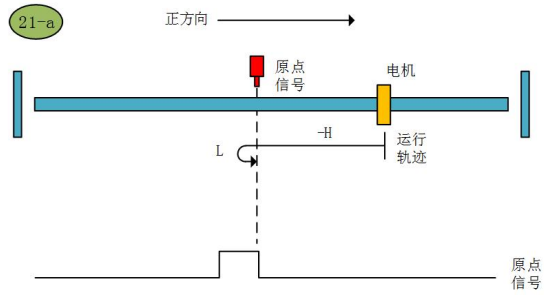

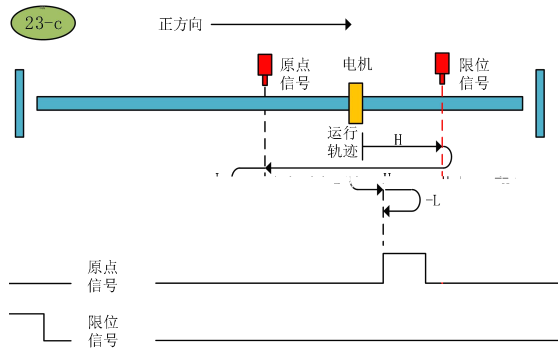
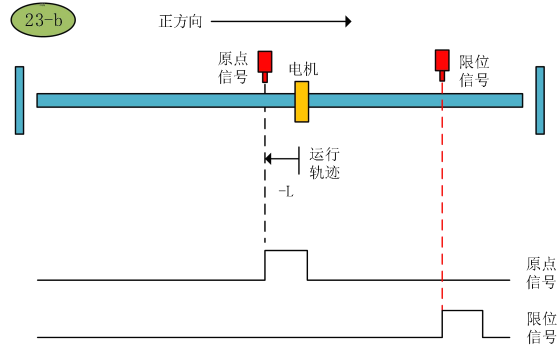
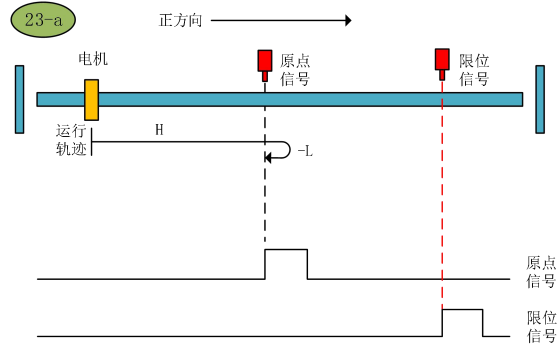





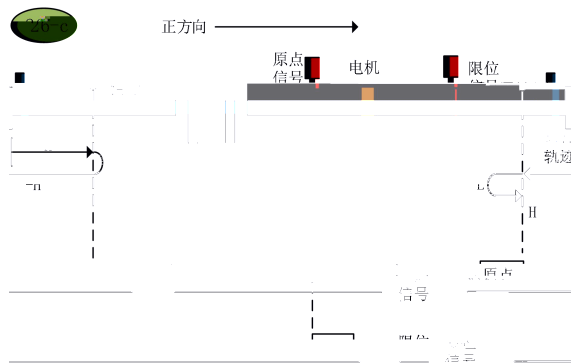
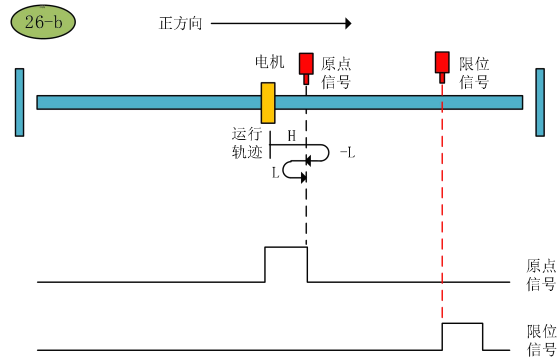
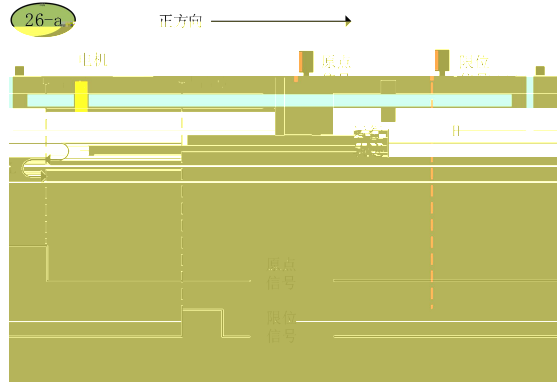

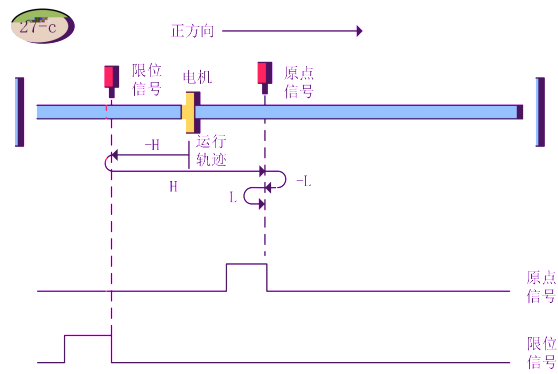
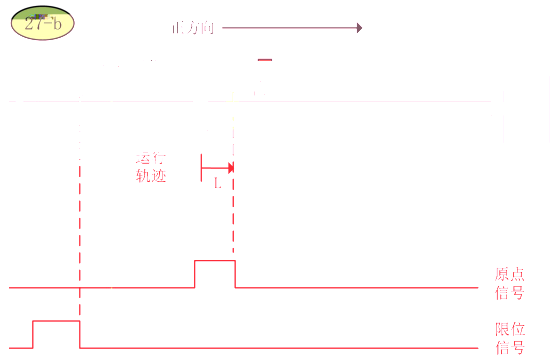
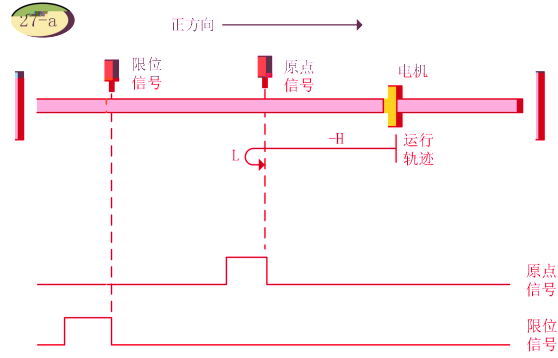

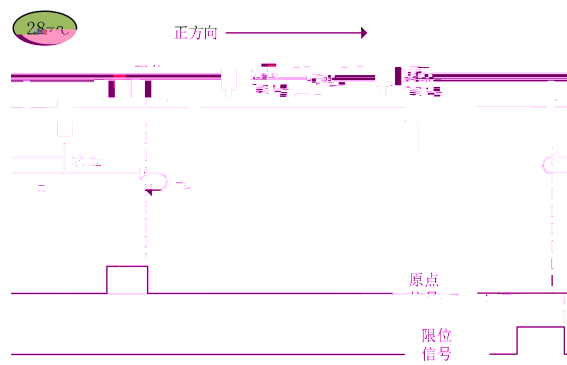
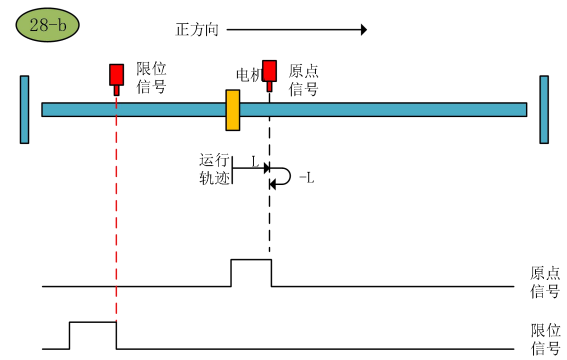
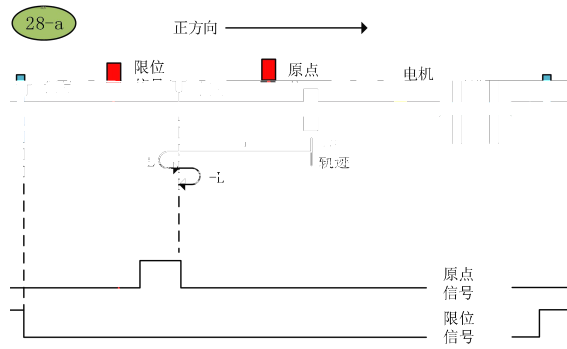





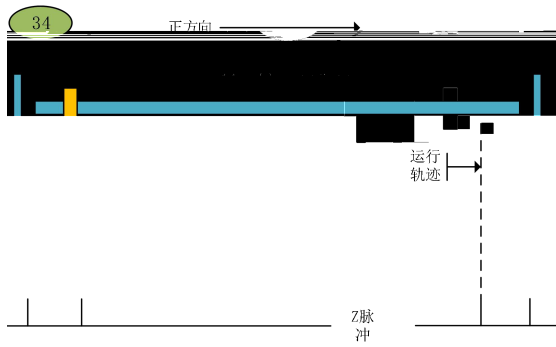
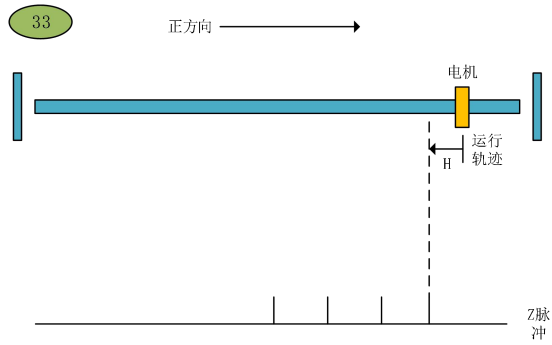

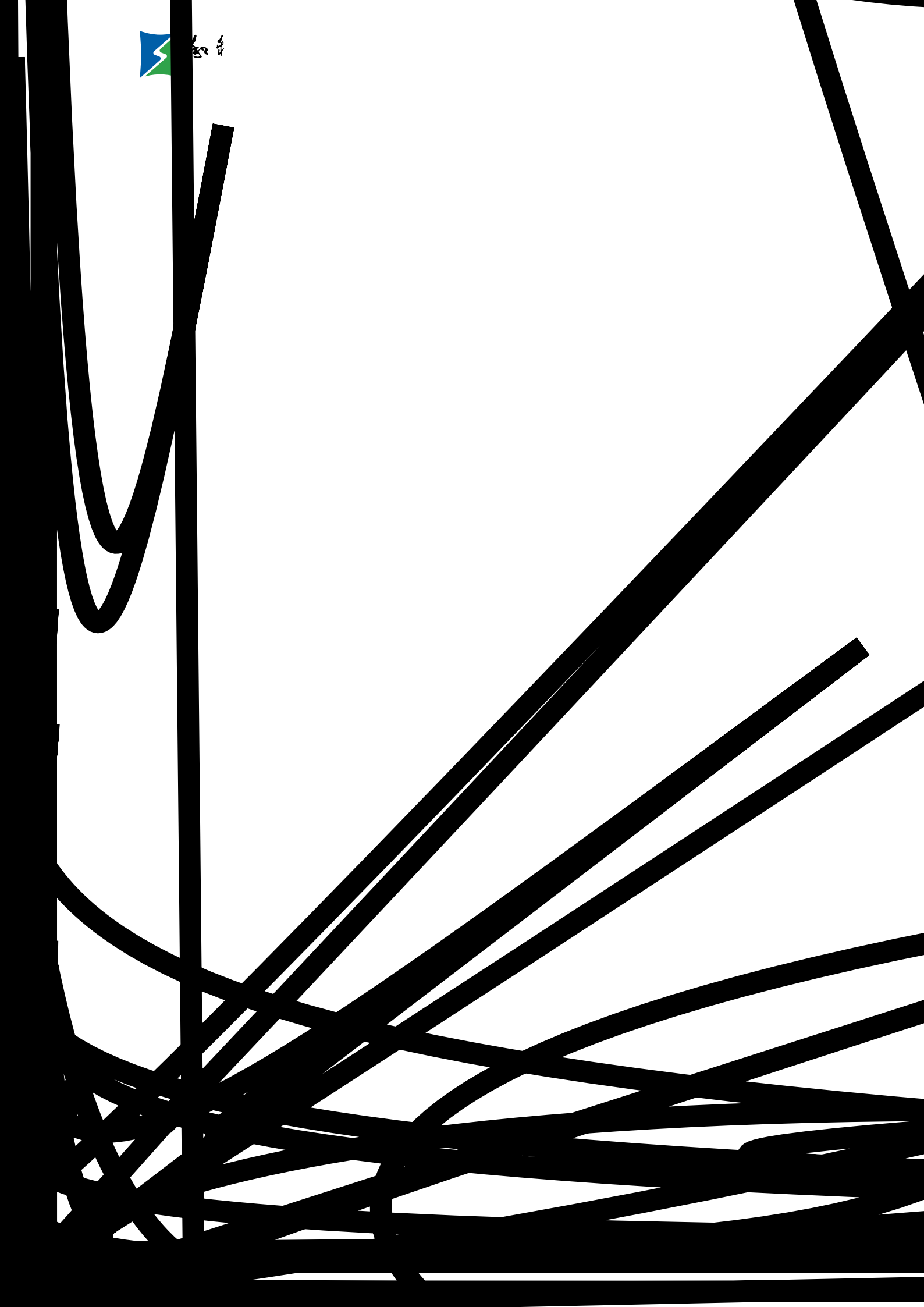













<table border="1" data-bbox="587 1133 1007 1223"> <tr> <td></td> <td></td> <td></td> </tr> <tr> <td></td> <td></td> <td></td> </tr> </table>											

<table border="1" data-bbox="536 1512 1058 1601"> <tr> <td></td> <td></td> <td></td> </tr> <tr> <td></td> <td></td> <td></td> </tr> </table>											

	↓				

€3RE	↓ / a Σ 0.8b				























$1000 \times 20\% = 200$					





) B.

4 4







<table border="1" style="margin: auto;"> <thead> <tr style="background-color: #cccccc;"> <th></th> <th></th> <th></th> </tr> </thead> <tbody> <tr><td></td><td></td><td></td></tr> <tr><td></td><td></td><td></td></tr> <tr><td></td><td></td><td></td></tr> <tr><td></td><td></td><td></td></tr> <tr><td></td><td></td><td></td></tr> <tr><td></td><td></td><td></td></tr> <tr><td></td><td></td><td></td></tr> <tr><td></td><td></td><td></td></tr> <tr><td></td><td></td><td></td></tr> <tr><td></td><td></td><td></td></tr> </tbody> </table>																																						
<table border="1" style="margin: auto;"> <tbody> <tr> <td></td> <td colspan="4"></td> </tr> <tr> <td></td> <td></td> <td></td> <td></td> <td></td> </tr> <tr> <td></td> <td></td> <td></td> <td></td> <td></td> </tr> <tr> <td></td> <td></td> <td></td> <td></td> <td></td> </tr> <tr> <td></td> <td></td> <td></td> <td></td> <td></td> </tr> </tbody> </table>																																						







<table border="1" style="margin: auto;"> <tr> <td></td> <td></td> <td></td> <td></td> <td></td> </tr> <tr> <td></td> <td></td> <td></td> <td></td> <td></td> </tr> </table>															



<table border="1" style="margin: auto;"> <tr> <td></td> <td></td> <td></td> <td></td> <td></td> <td></td> <td></td> <td></td> </tr> <tr> <td></td> <td></td> <td></td> <td></td> <td></td> <td></td> <td></td> <td></td> </tr> </table>																							

<table border="1" style="margin: auto;"> <tr style="background-color: #cccccc;"> <td></td> <td></td> </tr> <tr> <td></td> <td></td> </tr> <tr> <td></td> <td></td> </tr> <tr> <td></td> <td></td> </tr> </table>													





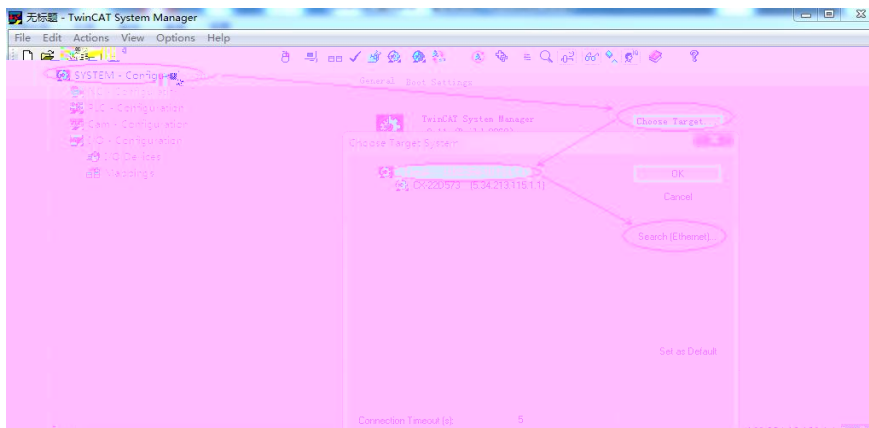
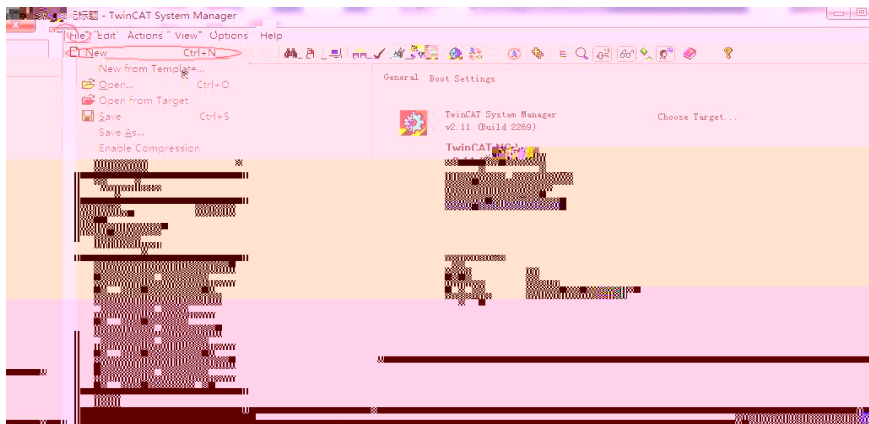
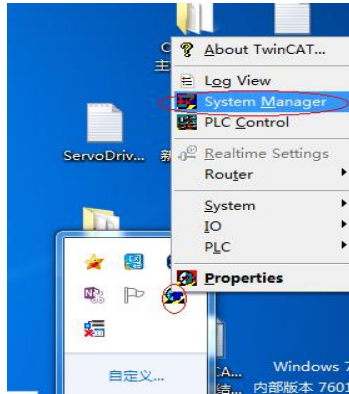

Add Route Dialog

Enter Host Name / IP: Refresh Status Broadcast Search

Host Name	Connected	Address	AMS NetId	TwinCAT	OS Version	Comment

Route Name (Target):

AmsNetId:

Transport Type: TCP/IP

Address Info:

Host Name IP Address

Connection Timeout (s): 5

Route Name (Remote): NB00098

Target Route: Project Static Temporary

Remote Route: None Static Temporary

Add Route Close

Add Route Dialog

Enter Host Name / IP: Refresh Status Broadcast Search

Host Name	Connected	Address	AMS NetId	TwinCAT	OS Version	Comment
C4220573	X	169.254.24...	534.213.115.1.1	2.11.2252	WinCE 7.0	
NB00098		169.254.18...	169.254.18.123	2.11.2252	Windows	

Route Name (Target): C4220573

AmsNetId: 534.213.115.1.1

Route Name (Remote): NB00098

Target Route: Project Static Temporary

Remote Route: None Static Temporary

Logon Information

Enter a user name and password that is valid for the remote system.

User name:

Password:

OK Cancel

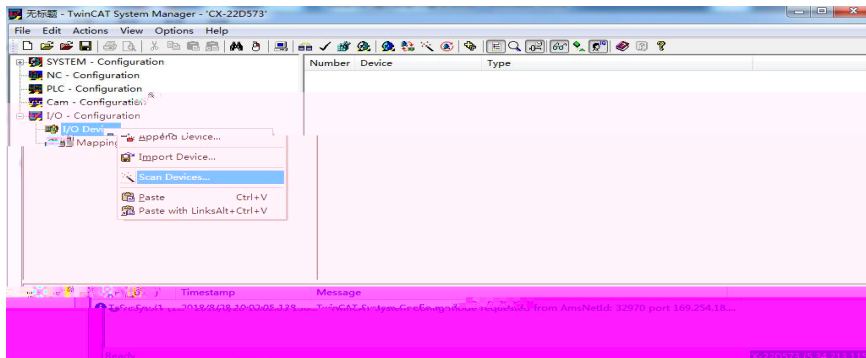
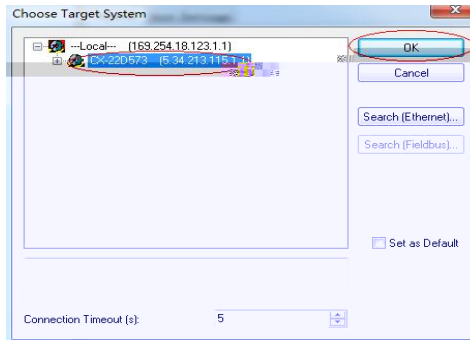
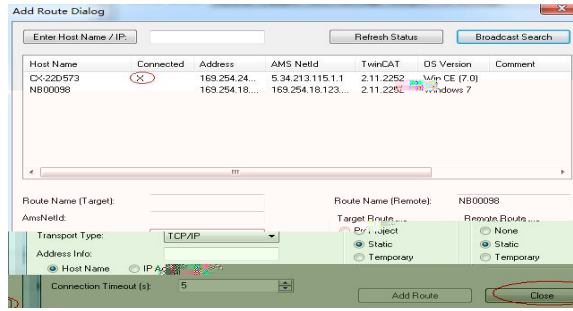

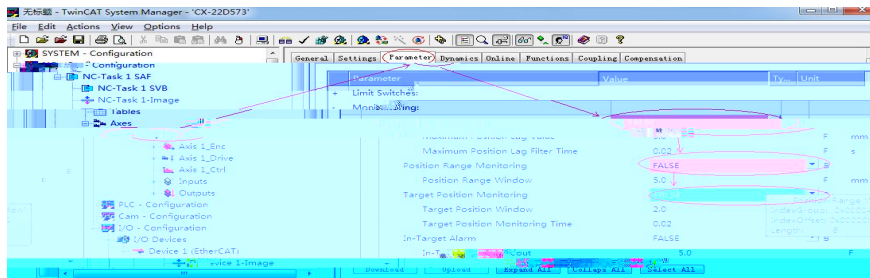
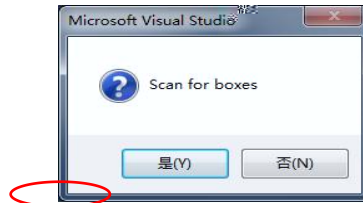
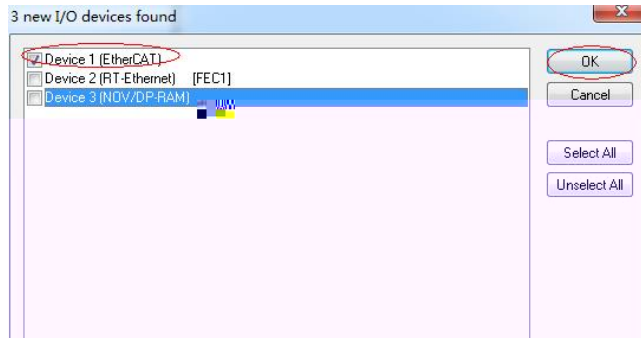







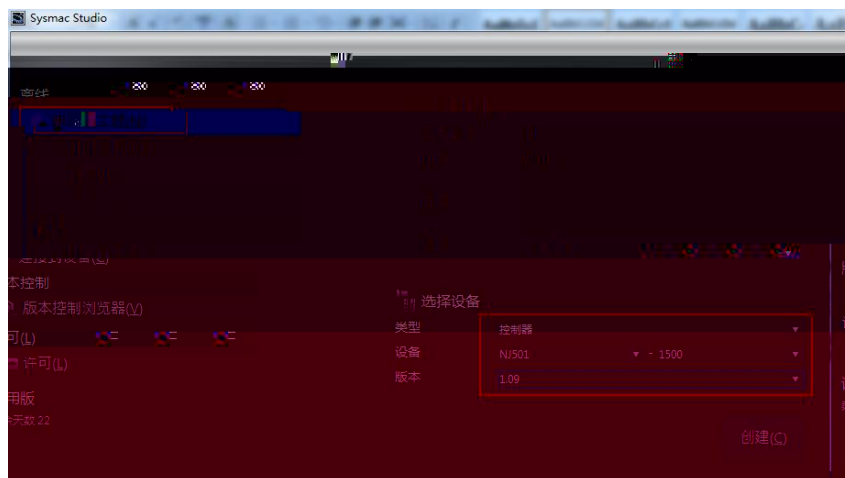
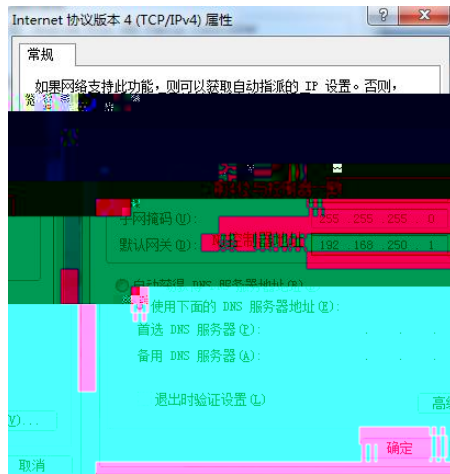

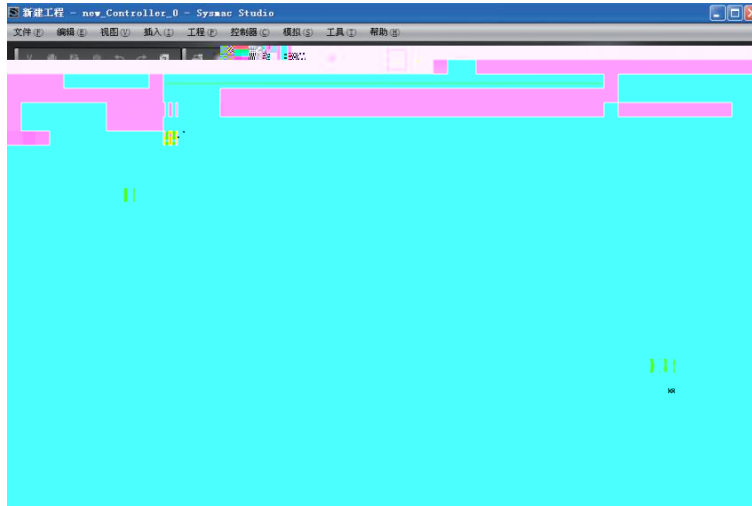

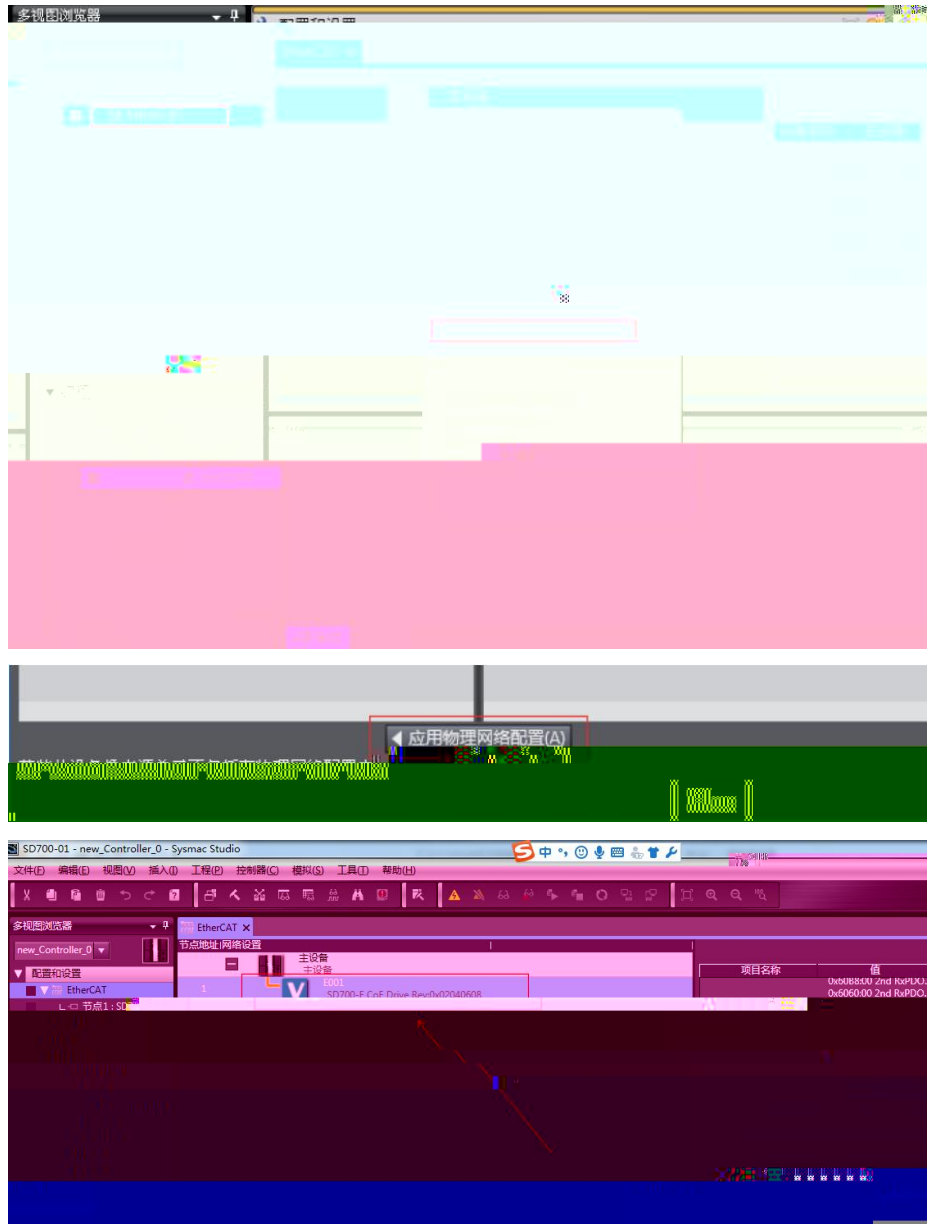

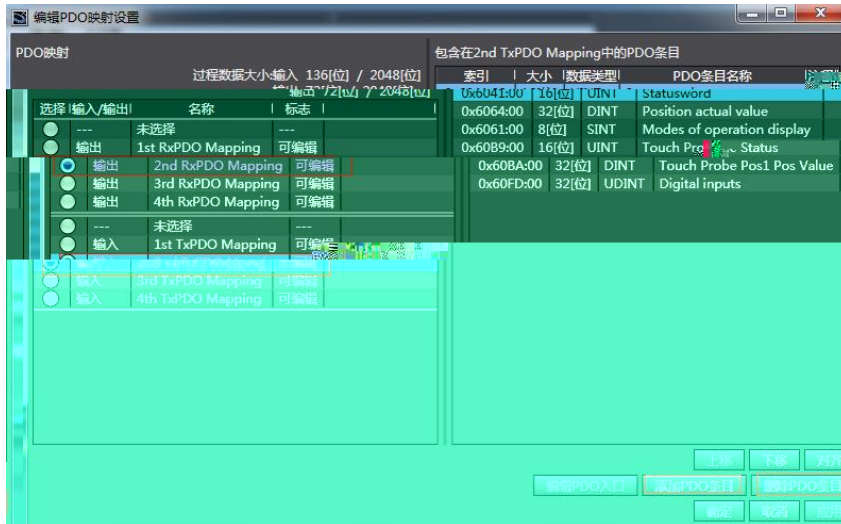
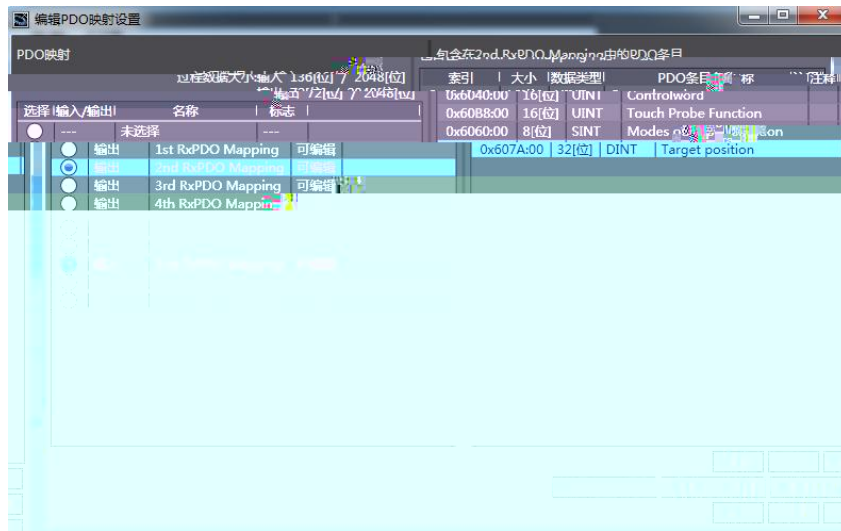
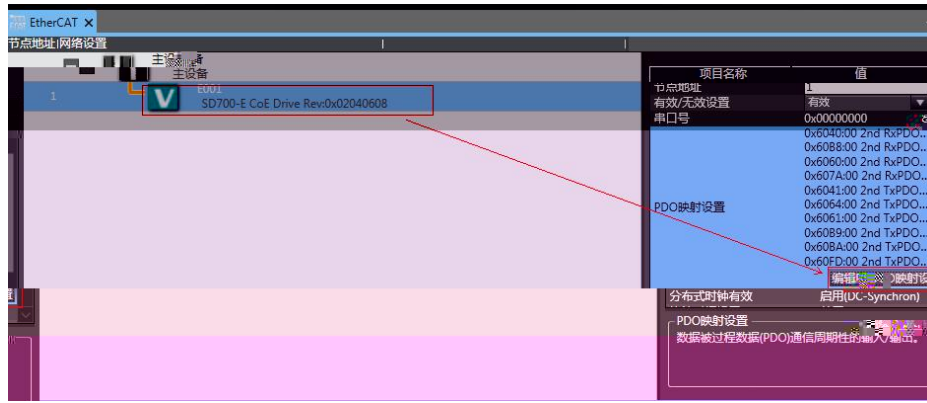

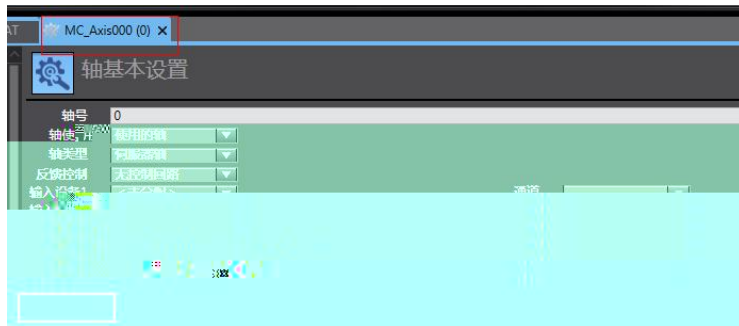
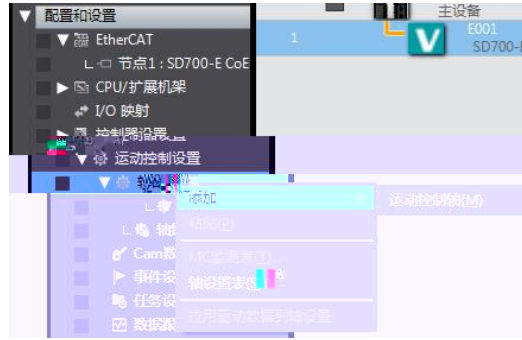

详细设置

恢复默认值

功能名称	设备	过程数据
输出(控制器到设备)		
1. Controlword	节点:1 SD700-E CoE Drive(E001)	6040h-00.0(2nd RxPDC)
3. Target position	节点:1 SD700-E CoE Drive(E001)	607Ah-00.0(2nd RxPDC)
5. Target velocity	<未分配>	<未分配>
7. Target torque	节点:1 SD700-E CoE Drive(E001)	<未分配>
9. Max profile Velocity	<未分配>	<未分配>
11. Modes of operation	节点:1 SD700-E CoE Drive(E001)	6060h-00.0(2nd RxPDC)
15. Positive torque limit value	<未分配>	<未分配>
16. Negative torque limit value	<未分配>	<未分配>
21. Touch probe function	节点:1 SD700-E CoE Drive(E001)	6088h-00.0(2nd RxPDC)
44. Software Switch of Encoder's Input	<未分配>	<未分配>
输入(设备到控制器)		
数字输入		

22. Statusword	节点:1 SD700-E CoE Drive(E001)	6041h-00.0(2nd TxPDC)
23. Position actual value	节点:1 SD700-E CoE Drive(E001)	6064h-00.0(2nd TxPDC)
24. Velocity actual value	<未分配>	<未分配>
25. Torque actual value	<未分配>	<未分配>
27. Mode of operation display	节点:1 SD700-E CoE Drive(E001)	6060h-00.0(2nd TxPDC)
40. Touch probe function	节点:1 SD700-E CoE Drive(E001)	6088h-00.0(2nd RxPDC)

28. Positive limit switch	节点:1 SD700-E CoE Drive(E001)	60FDh-00.1(2nd TxPDC)
29. Negative limit switch	节点:1 SD700-E CoE Drive(E001)	60FDh-00.0(2nd TxPDC)
30. Immediate Stop Input	<未分配>	<未分配>
32. Encoder Phase Z Detection	<未分配>	<未分配>
33. Home switch	节点:1 SD700-E CoE Drive(E001)	60FDh-00.2(2nd TxPDC)
37. External Latch Input 1	<未分配>	<未分配>
38. External Latch Input 2	<未分配>	<未分配>

